

ZICOM

USER MANUAL

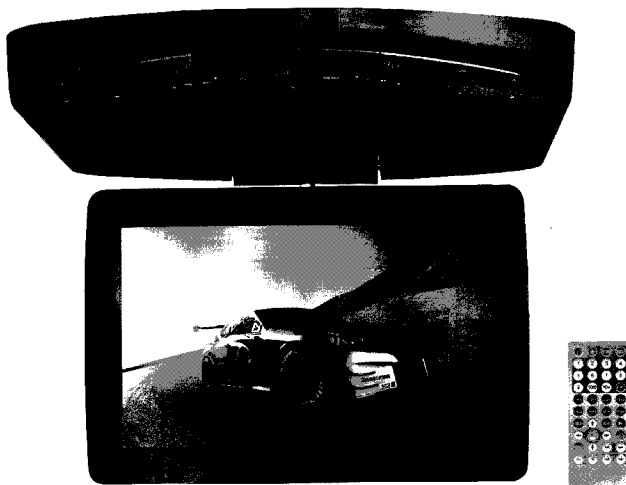

ZFA14W

BEFORE OPERATING THE UNIT, PLEASE READ THIS MANUAL
THOROUGHLY AND RETAIN IT FOR FUTURE REFERENCE

TABLE OF CONTENTS

A.Specifications	1
B.Wiring Diagram	1
C.Introduction of sketch map	2
D.Remote control panel function introduce	3
E.Remote control battery installs sketch map	3
Remote control panel using	4
G.Manual setup	5
1.PICTURE	5
2. OPTION	5
H.System setup	6
1.Initial setup	6
2.Audio setup	7
3.Doldiy setup	8
4.Video setup	8
5.Basic parameter setup	9
I.USB/SD function	10
J.Attention	10
Trouble Shooting	12

A. Specifications

- High Resolution 14 inch Active Matrix 16:9 Display.
- Resolution:1280x800
- Built-in slot-load DVD player
- Full DVD player Faceplate Controls.
- Type of disc: DVD-5, DVD-9, DVD-10, DVD-18, DVD±R/RW, CD-DA, CD-R, CD-RW, MP3, VCD, SVCD, MPEG-4.
- Supported memory Card: SD (Secure Digital Memory), MMC (Multi Media Card).
- Supported USB Host.
- 1 Audio & Video Output.
- 2 Audio & Video Input.
- Built-in IR transmitter. A (2.3/2.8 MHz) / B (3.2/3.8 MHz) OFF
- Built-in FM modulator. (87.7/88.1/88.5/88.9/106.7/107.1/107.5/107.9 MHz) OFF
- Mult-language Selection.
- Panel swivel: 270° (Left 90° and right 180°)
- Video System: NTSC/PAL/AUTO
- Dual Function Remote.
- Signal to Noise Ratio: ≥ 75 dB.
- Audio Output: 500 mV RMS.
- Operating Voltage: DC + 12V Input (10V-15V).
- Operating Temperature: -10°C ~ 60°C.

B. Wiring Diagram

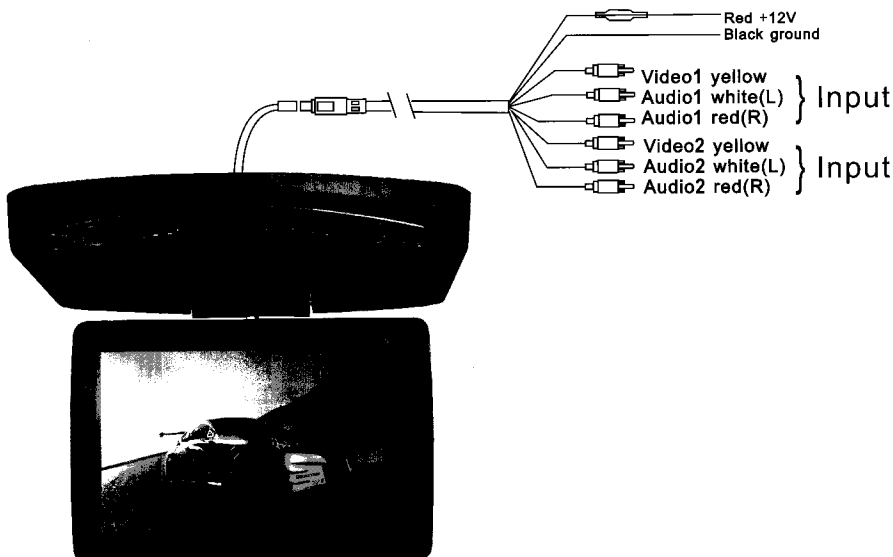

C. Introduction of sketch map

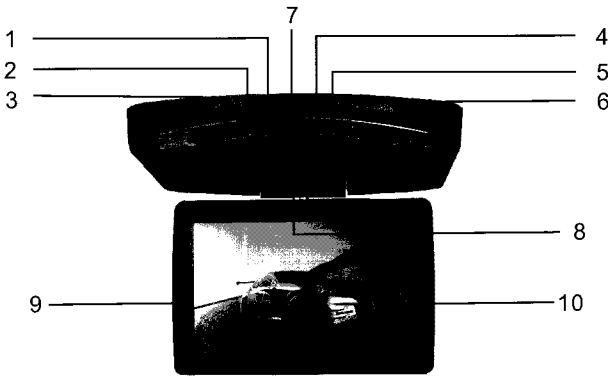

- 1.  Power (on/off)
- 2.  NEXT / Down
- 3.  PREV / Up
- 4. MENU MENU
- 5.  $\frac{SD}{USB}$ /  USB, SD Switch/Left
- 6.   /  Play Stop/Right
- 7.  Light switch
- 8. OPEN Open button
- 9. Remote receiver
- 10. IR Transmitter

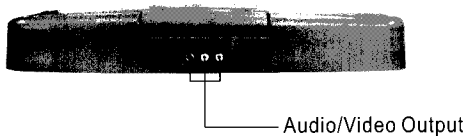

D.Remote control panel function description

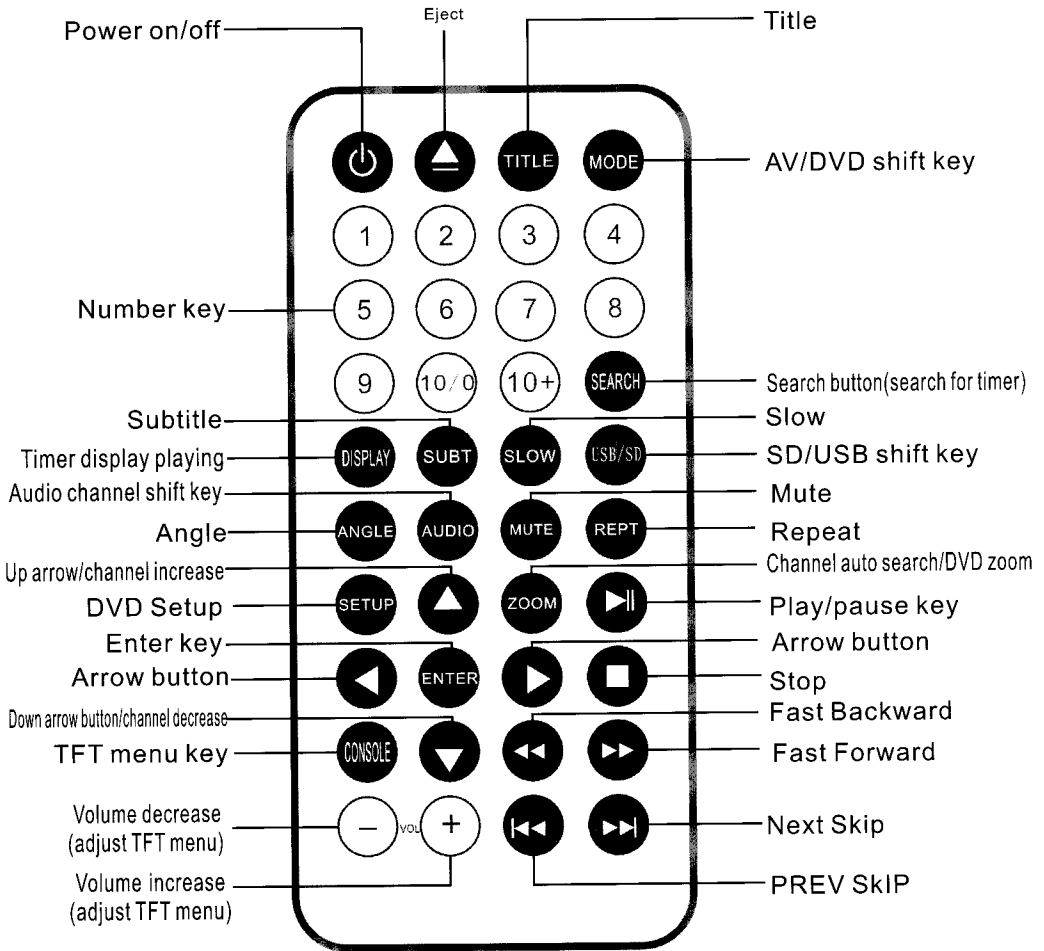

E.Remote control panel using

- 1.Reference to instruction for remote control(shown as pictures),pull out the battery tray and insert the battey(type CR2025)with the stamped(+) mark facing upward. Insert the battery tray into the remote control.
- 2.Direct the remote controller to infrared receiver window of the machine with in 60 degree and 5 metres without any barriers between them.

3. Commonly the life-span of the batteries is about one year, always replace the old set of new batteries.

4. Please take out the battery when not using the remote controller for a long time.

5. Please pull out the separation film before when using the remote controller

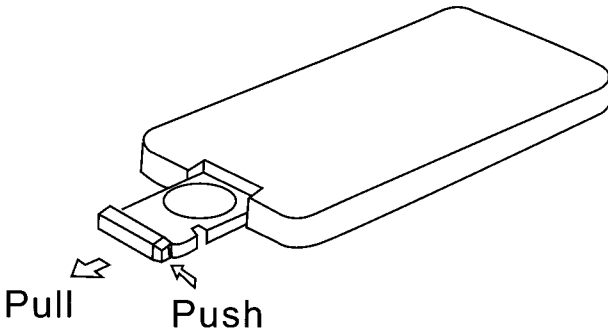

WARNING:

Store the battery where children cannot reach; Do not recharge, short, disassemble or heat the battery or dispose it in a fire.

