

ZICOM

ZFA11W3

**11" TFT-LCD DVD
COMBO MONITOR**

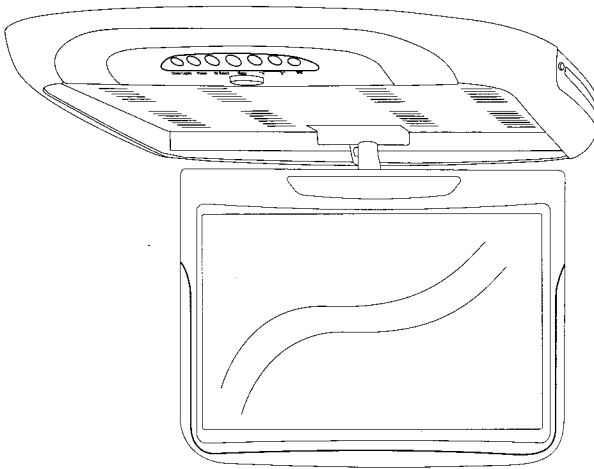

OWNER'S MANUAL

Contents

▪ Caution.....	4	Mute	24
▪ Features and Controls	6	Play or Pause	24
Monitor/DVD Player.....	6	Audio	24
Remote Control.....	8	Stop	25
▪ Power and Mode Selection	10	Arrows	25
Releasing The Monitor.....	10	Setup	25
Turning on The Monitor.....	10	Menu	25
Mute Function.....	10	Display.....	26
AV mode	11	Number Buttons.....	26
▪ Picture Control	12	Subtitle.....	27
Contrast/Brightness/Color/FM	12	Title	27
▪ DVD Setup	13	Slow	27
Setup Menu.....	13	Fast Reverse Searching	28
General Setup.....	14	Fast Forward Searching.....	28
TV Aspect Ratio.....	14	Previous	29
Angle Viewing	14	Next	29
OSD Language	14	Repeat A-B	29
Screen Saver	15	Repeat	30
Audio Setup.....	15	NTSC/PAL.....	30
Dolby Digital Setup.....	16	Angle	30
Equalizer Settings.....	16	PBC.....	31
Video Setup.....	18	Zoom.....	31
Quality	18	GO TO.....	31
Preferences Setup.....	21	▪ Connection Diagram	32
TV Type.....	21	▪ Installation	33
PBC	21	▪ Disc Information	34
Audio	21	▪ Troubleshooting.....	35
Subtitle.....	21	▪ Specifications.....	36
Disc Menu	22		
Parental.....	22		
Default	22		
Password Setup.....	23		
Password Mode	23		
Password Change.....	23		
▪ DVD Functions	24		
Eject	24		
Vol+/Vol-.....	24		

Caution

Please read and observe all warnings and instructions in this manual and those marked on the unit. Retain this booklet for future reference.

There are two kinds of alarm symbols as follows:



WARNING

The lightning bolt with arrowhead inside in an equilateral triangle is intended to alert the user to the presence of "dangerous voltage" within the product's enclosure that may be of sufficient magnitude to constitute a risk of electric shock to people.



CAUTION

The exclamation point inside an equilateral triangle is intended to alert the user to the presence of important operating and maintenance (servicing) instructions in the literature accompanying the product.



WARNING

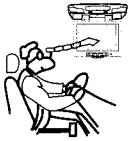

Installation of all TV monitors must be out of the driver's field of vision.



Do not mount the product where it will obstruct the deployment of the airbag or in an area where it would affect the driver's ability to control the vehicle. Also be careful to avoid mounting the product where it can become hazardous during sudden stops or in the event of an accident.



Do not try and service these products yourself, locate a qualified service center or factory service center for all repairs.



Use extra caution with any liquids in your car. If you or your child spills any liquid on these products, pull your vehicle to the roadside and turn the key off to disconnect or wipe the products with a towel. Do not operate the equipment until all liquids have either evaporated or you have had the monitor inspected at a service center by a qualified technician. Severe harm or danger can result.



Be careful not to drop or apply under pressure to the front panel of your video monitor. If the screen cracks due to misuse, your warranty will be void!



Use only a damp cloth to clean the screen and use only purified water on the cloth. wring out all excess water prior to wiping the screen. Do not use any cleaners or chemicals to clean the screen. In most cases a dry cloth will do!

CAUTION



Quality installations are best performed by qualified and certified installers.



Watching the monitor for an extended period of time without the engine running may deplete the vehicle's battery charge.



Don't touch the unit if there is a flash of lightning. You may receive an electric shock.

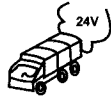

This product is designed for operation with a 12 Volt DC, negative ground vehicle. It is not suitable for operation under other conditions or voltages.

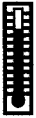

Do not cover or stop up heater ducts or vents. It may cause a fire or receive an electric shock.

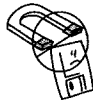

Do not bring magnetic devices such as credit card or magnetic card near the magnets.

Operating Notes

1. The operating temperature of this product is limited to 14°~+140°F.
2. If your vehicle is extremely hot or cold you must allow time for your air conditioner or heater to cool or heat the vehicle until operating temperatures have returned to normal operating ranges.
3. Optimal picture quality is achieved when viewed from directly front of the monitor (+/-30degrees).
4. Do not open the housing and attempt to make any repairs yourself. Refer servicing to qualified personnel.
5. DVD Players use an invisible laser beam which can cause hazardous radiation exposure. Be sure to operate the unit correctly as instructed.
6. Do not cut the car power supply off while a disc is playing. It can cause damage to the DVD Player.

Features and Controls

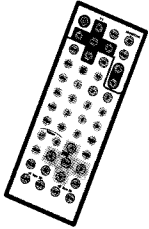

Remote Control

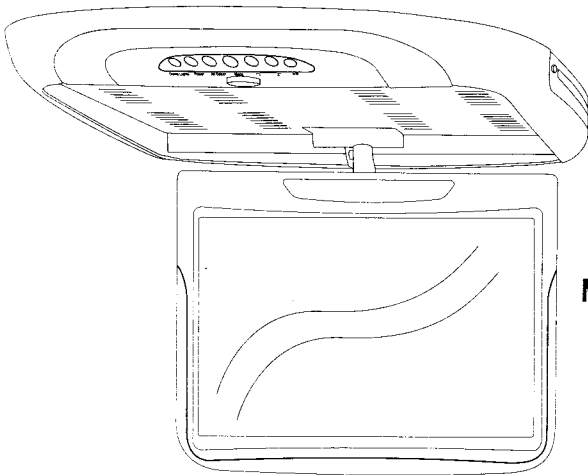

Monitor/DVD Player



**Wireless Headphones
(Not Included)**

Features and Controls

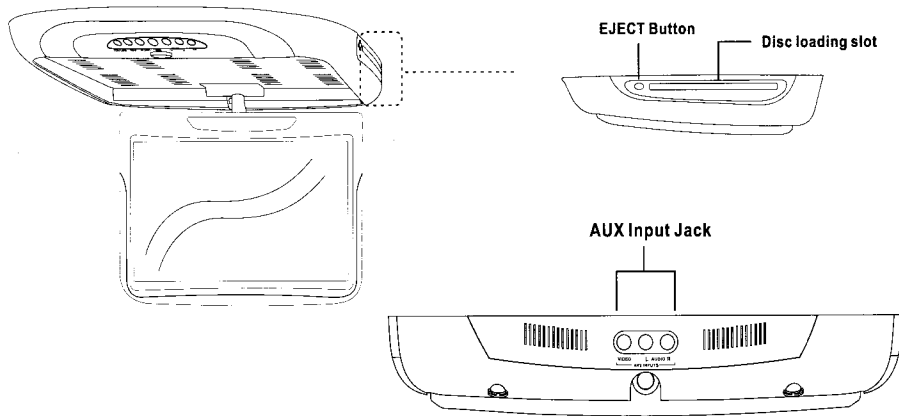
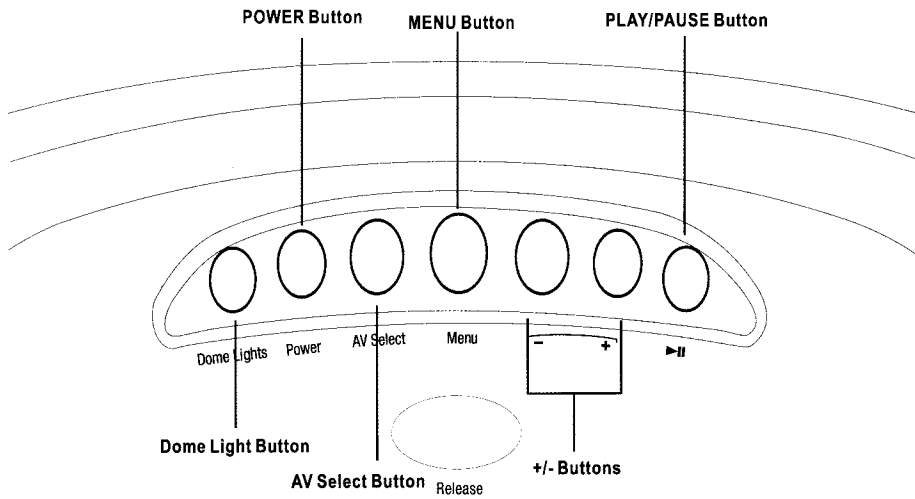

* Caution

Do not bring magnetic devices such as credit cards or magnetic cards near the monitor.

Remote Control

- ① **POWER**
Turns the DVD Player/Monitor on or off.
- ② **MUTE**
Press this button to switch off the audio during playback. Press again to restore the audio.
- ③ **Auto (TV)** (not function in this unit)
- ④ **UP/DOWN/RIGHT/LEFT ARROWS**
(not function in this unit)
- ⑤ **A/V SELECT**
DVD→AV1→AV2
- ⑥ **MENU (OSD on monitor)**
Press this button to open the on-screen menu system to setup and control various parameters of the monitor and DVD player.
- ⑦ **UP/DOWN**
Use to move to the desired menu.
- ⑧ **P/N**
This button permits you to choose among Multi, PAL and NTSC.
- ⑨ **MODE**
(not function in this unit)
- ⑩ **MENU (DVD menu)**
This button permits you to view the menu on the DVD.
- ⑪ **SUBTITLE**
Use this button to select the menu for choosing a subtitle language.
- ⑫ **TITLE (Title menu)**
When a DVD is playing, press this button to view the Title Menu.
- ⑬ **DISPLAY**
Press to show elapsed or remaining time of a chapter or a title.
- ⑭ **PBC (Video CD only)**
Press this button to access the special Playback Control functions for VCD 2.0 format Video CD'S.
- ⑮ **NUMERIC button**
Use when making a selection on the menu screen.

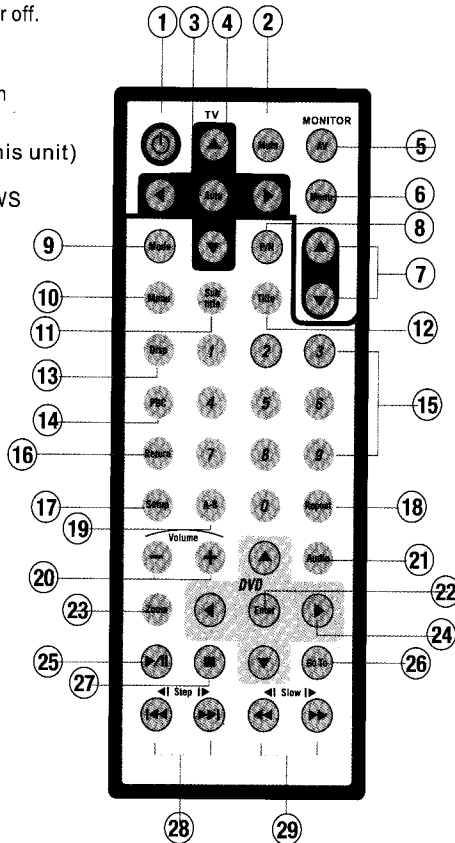

- ⑯ **RETURN**
Press this button to return to the root menu.
- ⑰ **SETUP**
Press this button to display the Setup menu. The Setup menu enables you to enter the settings required for the unit to work properly.
- ⑱ **REPEAT**
Press this button to change the playback mode to repeat.

Features and Controls

- 19** A-B (repeat from A to B)
Use this button to select the beginning and end of a track which you wish to have repeat in playback.
- 20** VOL-/+ button
Use to increase or decrease volume level.
- 21** AUDIO
Use this button to select one of the audio soundtracks programmed on a DVD disc. It is also used to select the audio output mode for the DVD playback.
- 22** ENTER
Press this button to confirm the item you have found and highlighted using the arrow buttons. Usually this is done to confirm a selection or item to be played on the DVD.
- 23** ZOOM
If your DVD disc supports zooming in to see the program differently, pressing this button will enable you to change the amount of zoom.
- 24** UP/DOWN/RIGHT/LEFT ARROWS
Use these buttons to navigate the various menus and screens for the monitor and DVD systems.
- 25** PLAY/PAUSE
To start playback of a disc, press this button. Press again to pause the playback. If playback is paused, press this button to resume playback.
- 26** GO TO
Use to search for a title or a chapter on your DVD disc.
- 27** STOP
Press this button to stop the playback of the current disc.
- 28** SKIP FORWARD/BACK
Use these buttons to skip to the next or last track, chapter or file on the disc in the player.
- 29** FAST FORWARD/REVERSE PLAY
Use these buttons to select either fast forward or fast reverse playback.

Power and Mode Selection

Releasing The Monitor

Push the release button (located on the front edge of the screen housing) and lower the monitor. You can also adjust the swivel angle.

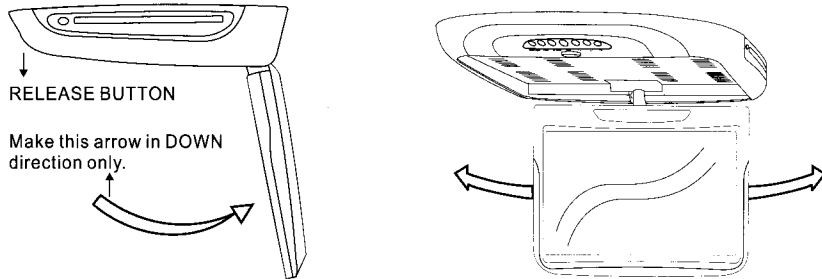

Turning on The Monitor

1. Connect the monitor to external devices.
2. Press the **POWER** button on either the remote control or the unit once to turn the power on.

Press the same **POWER** button to turn the power off.

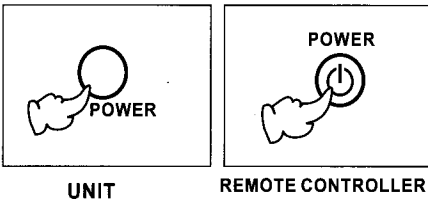

3. Power on the external devices and play.

Mute Function

1. Press the **MUTE** button on the remote control to mute the audio.
2. Press the **MUTE** button again on the remote control to return to the previous volume level.

